

Scintillation Probe NaI-MegaPixel-MCA



Scintillation Probe NaI-MegaPixel-MCA

Benefits

- High sensitivity – 40 cc of NaI scintillator
- Ultra compact design
- Fully solid state detector not sensitive to magnetic field
- IP67 dust proof and water resistant
- Operating temperature: -20 to 50°C
- Temperature stabilization and pulse pile-up rejection



Description

Ultra-lightweight and compact **NaI-MegaPixel-MCA** Scintillation Gamma Radiation Detection Probe with 28x28x50.8 mm (40 cc) NaI(Tl) crystal coupled to SiPM array and read by tiny USB MCA.

NaI(Tl) sensor with on the chip temperature stabilization and pulse pile-up rejection, as well as rugged watertight IP67 housing, makes NaI-MegaPixel-MCA perfectly suited for field or lab applications.

A user-friendly GUI for Windows and Android devices is included with the detector.

Specifications

Detector type	NaI(Tl)
Detector size	28x28x50.8 mm
Energy range	10 – 4000 keV
Maximum count rate, cps	50000
Typical resolution	6.5% at 662 keV
Typical sensitivity to gamma radiation, cps/($\mu\text{Sv}\cdot\text{h}^{-1}$)	690 (^{137}Cs) 515 (^{60}Co)
Protection class	IP67
Interface	Micro USB Type B
Operation temperature	-20°C to +50°C
Dimensions	31x31x95 mm
Weight	175 g

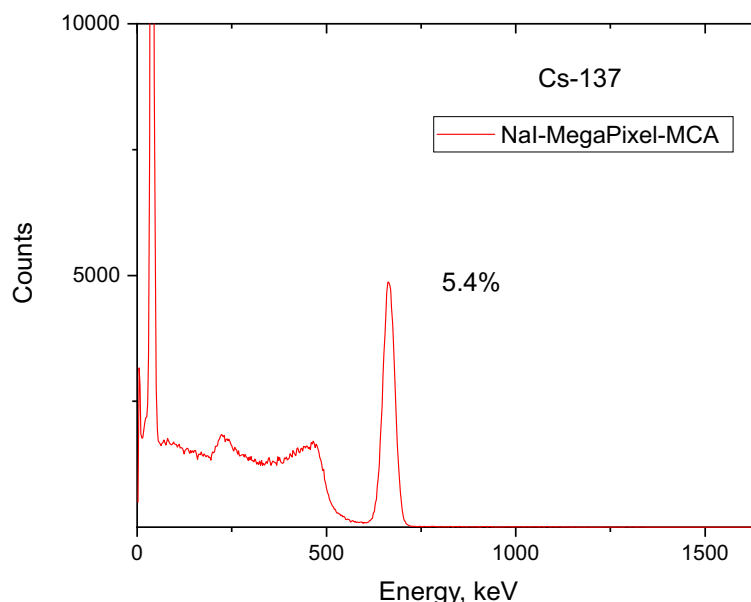

NaI(Tl) inorganic scintillation crystals have moderate light output of 40,000 photons/MeV, primary decay time about 250 ns, reasonable density of 3.7 g/cc, and peak emission wavelength about 415 nm. Energy resolution of NaI-MegaPixel-MCA is typically near 6.5% at 662 keV.

Scintillation Probe NaI-MegaPixel-MCA



Unambiguous Identification with NaI (All spectra taken with NaI-MacroPixel-MCA Scintillation Probe)

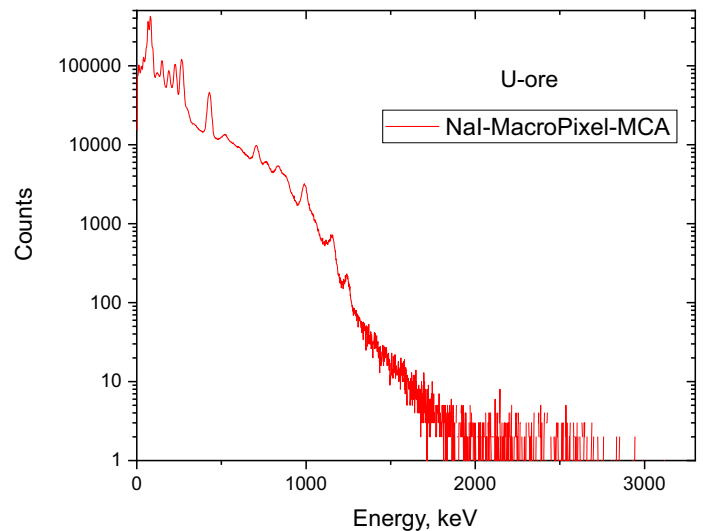
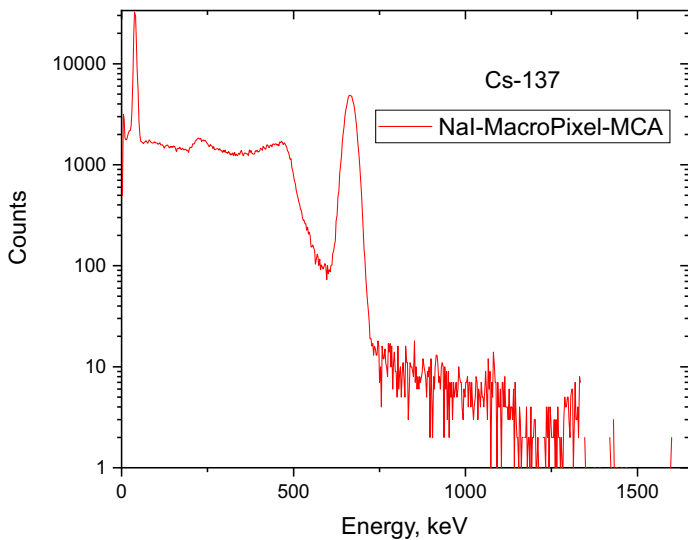
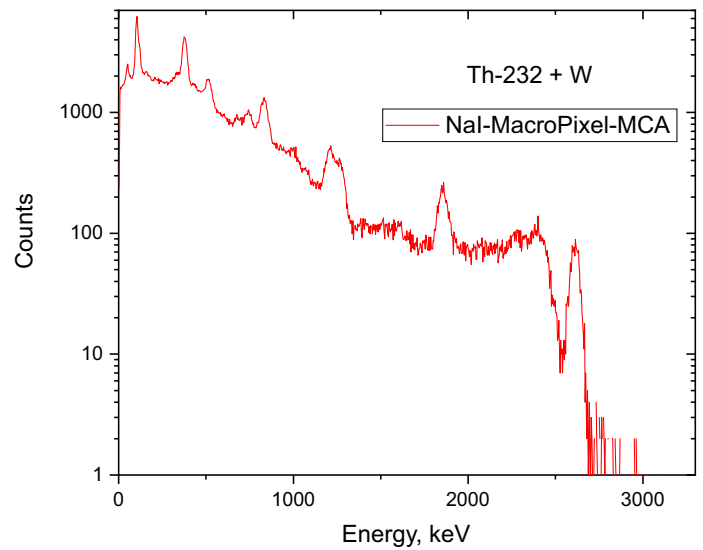
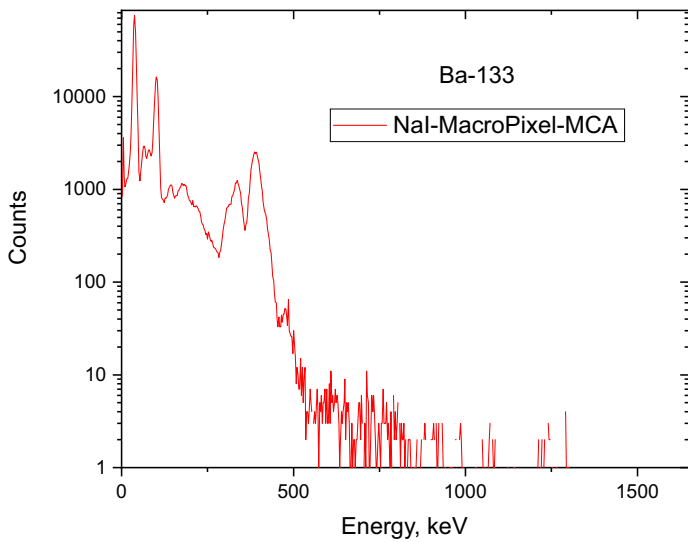
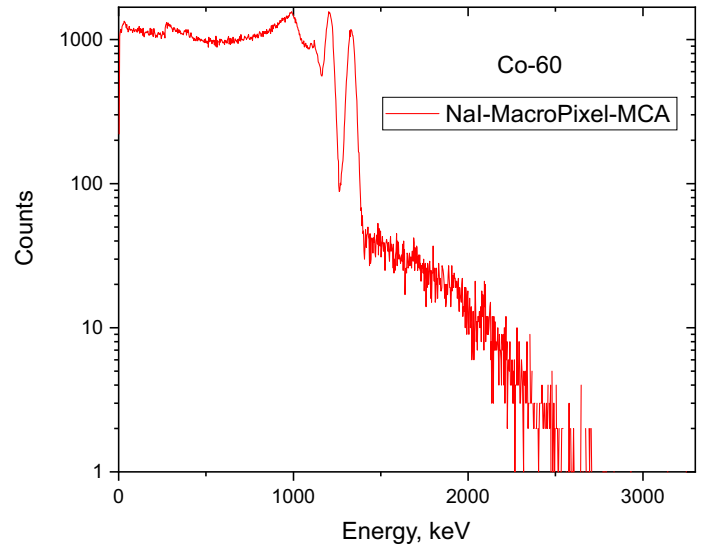
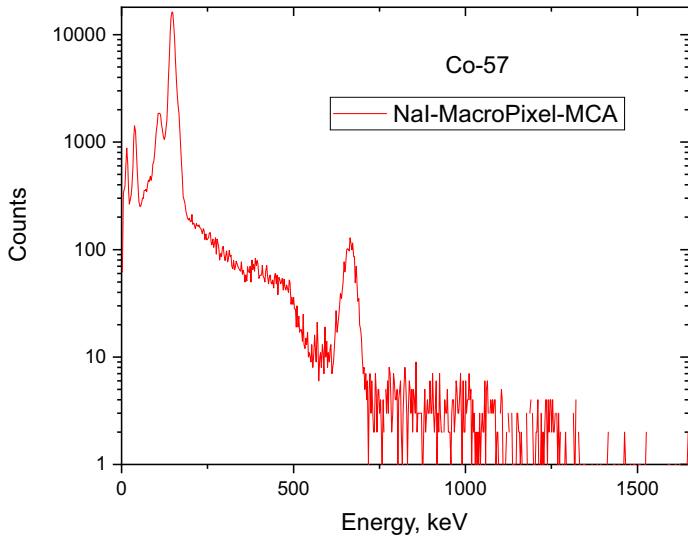

Scintillation Probe NaI-MegaPixel-MCA



2D drawing

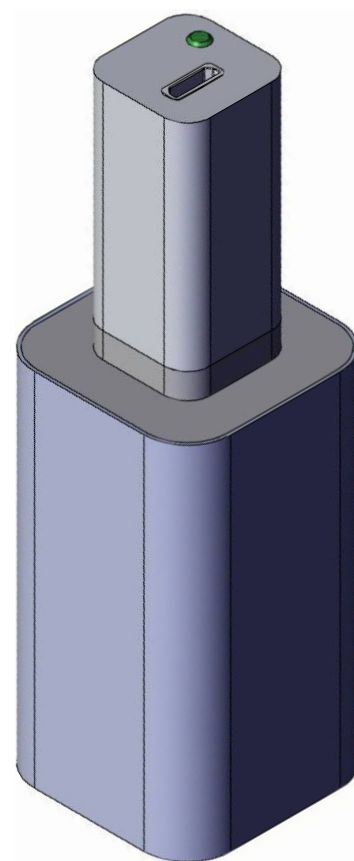
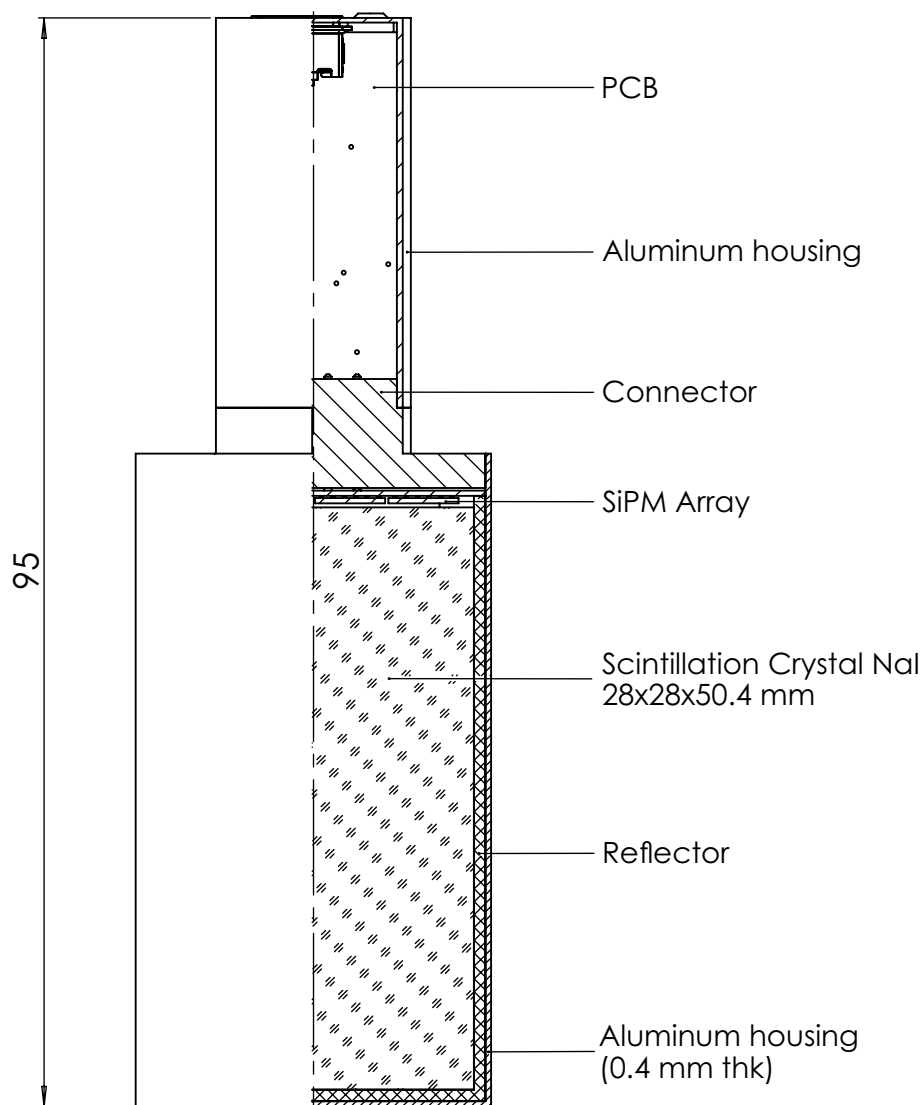
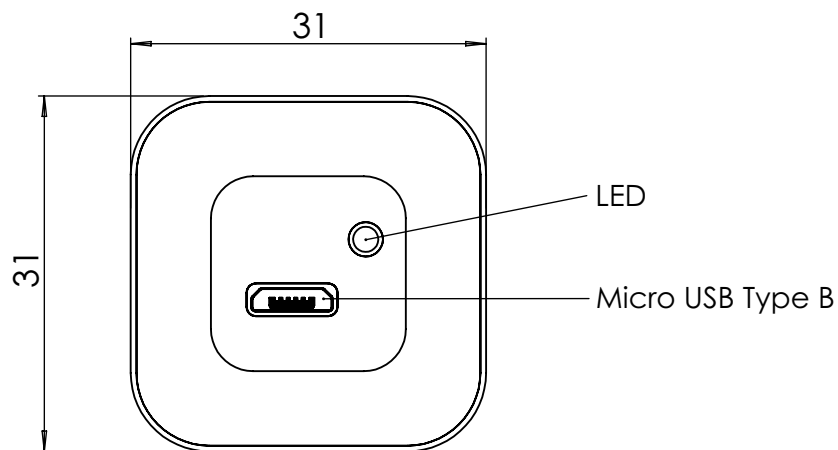



About CapeScint

CapeScint is a subsidiary of CapeSym, Inc. a multi-faceted company with 100+ years of combined experience in scintillators, semiconductors, and radiation detection instruments. CapeScint has its warehouse facilities and customer support staff located in Greater Boston Area, Massachusetts, USA.

Founded in 1992 as Cape Simulations, CapeSym, Inc. is now a multi-faceted company offering novel technical crystals and detectors for nuclear detection, including ScintiClear™ SrI₂(Eu) and Elpasolight™ CLYC(Ce) scintillators. In addition, CapeSym offers radiation detection instruments and equipment through www.zievert.com.



Our ongoing R&D leverages decades of experience in crystal growth, solid state physics, analytical chemistry, materials science, thermo-fluid transport, and engineering design. CapeScint as a subsidiary of CapeSym, Inc. has a long history working with the US Government as a contractor and as a supplier of essential goods and services. During the last 30 years CapeSym, Inc. and supported missions of multiple US Government agencies including NASA, MDA, USAF, DoE, DTRA, NIH, CWMD, and US Navy.



Design and specifications are subject to change without notice