

# Scintillation Probe nEL-MegaPixel-MCA



**Scintillation Probe nEL-MegaPixel-MCA**

## Benefits

- Sensitive to gamma and neutron radiation
- High sensitivity – 40 cc of Elpasolite (CLYC) scintillator
- Ultra compact design
- Fully solid state detector not sensitive to magnetic field
- IP67 dust proof and water resistant
- Operating temperature: -20 to 50°C
- Temperature stabilization and pulse pile-up rejection

## Description

Ultra-lightweight and compact **nEL-MegaPixel-MCA** Scintillation Gamma Neutron Radiation Detection Probe with 28x28x50.8 mm (40 cc) high-performance Elpasolite (CLYC) crystal coupled to SiPM array and read by tiny USB MCA.

Gamma Neutron Elpasolite sensor with on the chip temperature stabilization and pulse pile-up rejection, as well as rugged watertight IP67 housing, makes nEL-MegaPixel-MCA perfectly suited for field or lab applications.

A user-friendly GUI for Windows and Android devices is included with the detector.

## Specifications

Detector type	Cs <sub>2</sub> LiYCl <sub>6</sub>
Detector size	28x28x50.8 mm
Energy range	20 – 4000 keV
Maximum count rate, cps	20000
Typical resolution	6% at 662 keV
Typical sensitivity to gamma radiation, cps/(μSv·h <sup>-1</sup> )	635 ( <sup>137</sup> Cs) 480 ( <sup>60</sup> Co)
Neutron detection	Yes
Protection class	IP67
Interface	Micro USB Type B
Operation temperature	-20°C to +50°C
Dimensions	31x31x95 mm
Weight	160 g

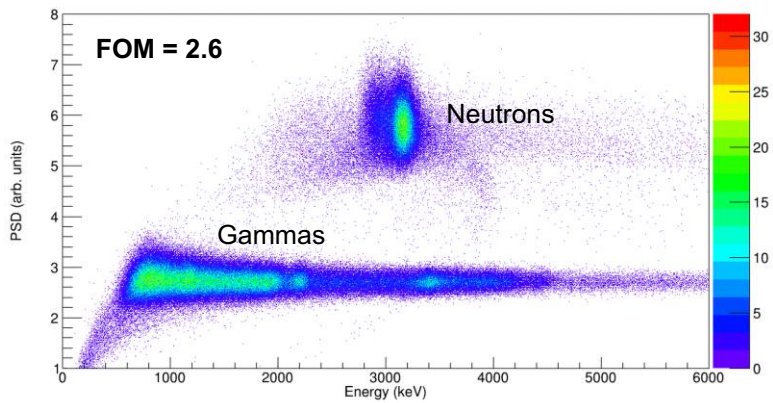
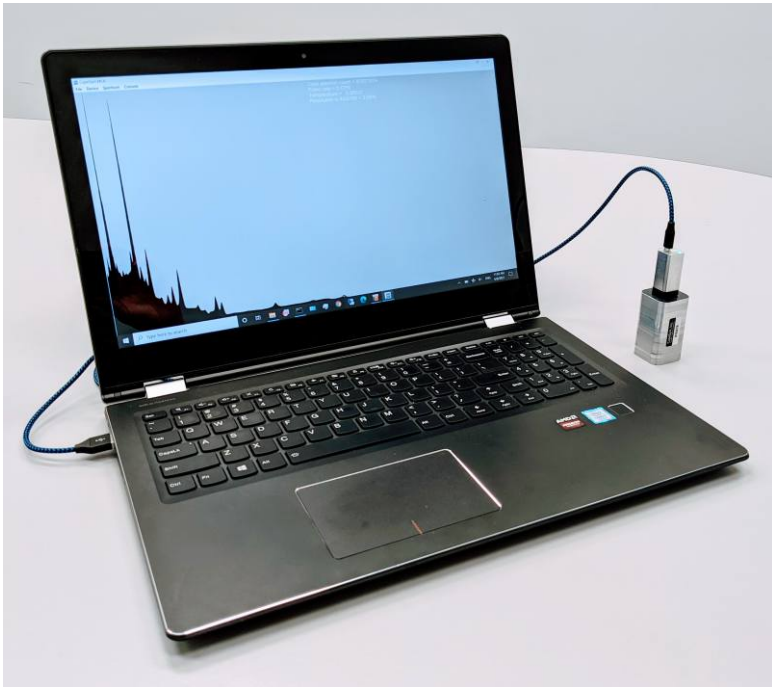

nEL crystals incorporate 7% 6-Li permitting thermal neutron detection, while Cl-35 enables fast neutron detection. The emission of nEL is comprised of fast core-valence luminescence (CVL) and Ce related emission resulting in two main decay components. Absence of CVL under neutron excitation allows for easy discrimination between the neutron and gamma radiation. An FOM value of 2.6 was achieved using a Pu/Be neutron source.

# Scintillation Probe nEL-MegaPixel-MCA



Unambiguous Identification with Elpasolite  
(All spectra taken with nEL-MacroPixel-MCA Scintillation Probe)

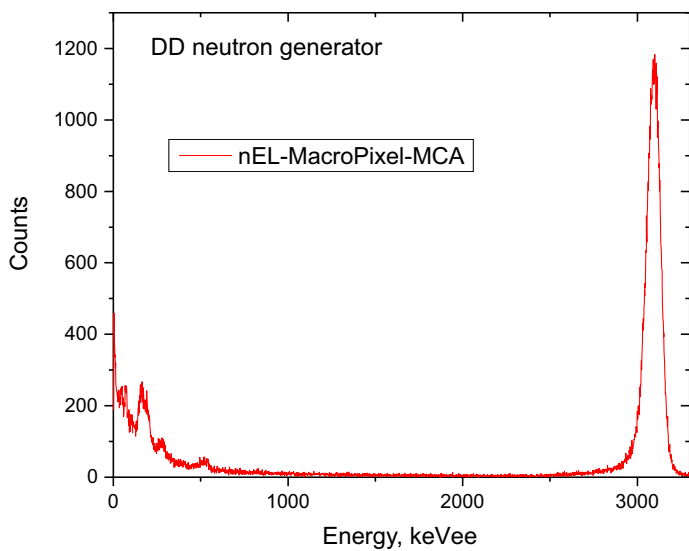
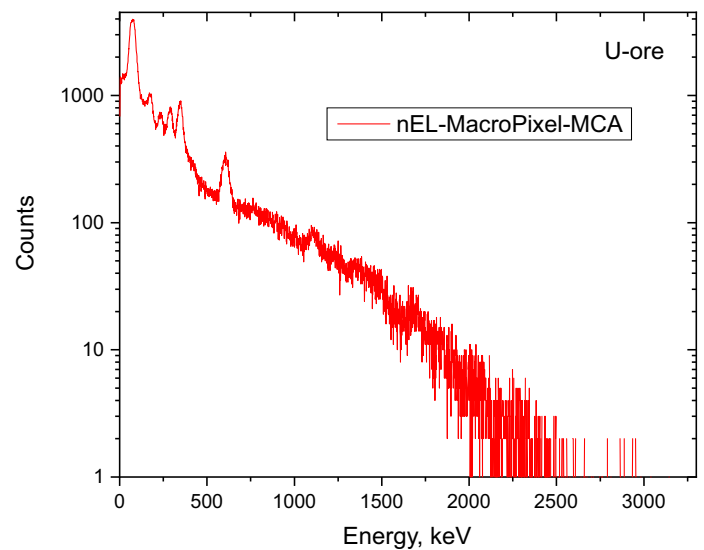
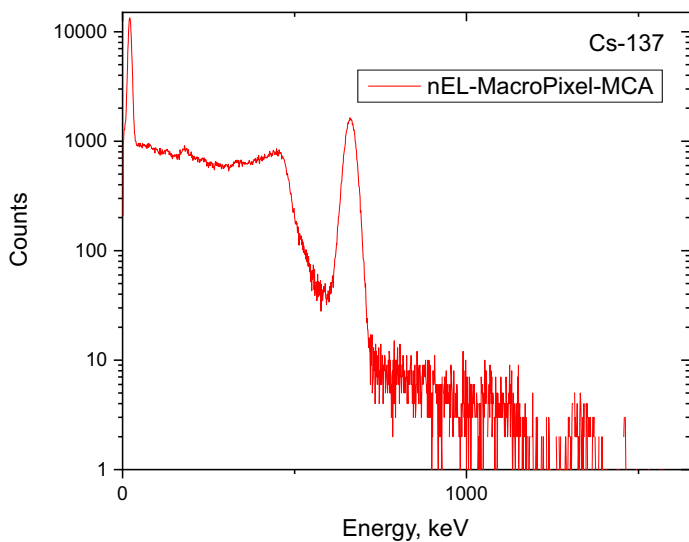
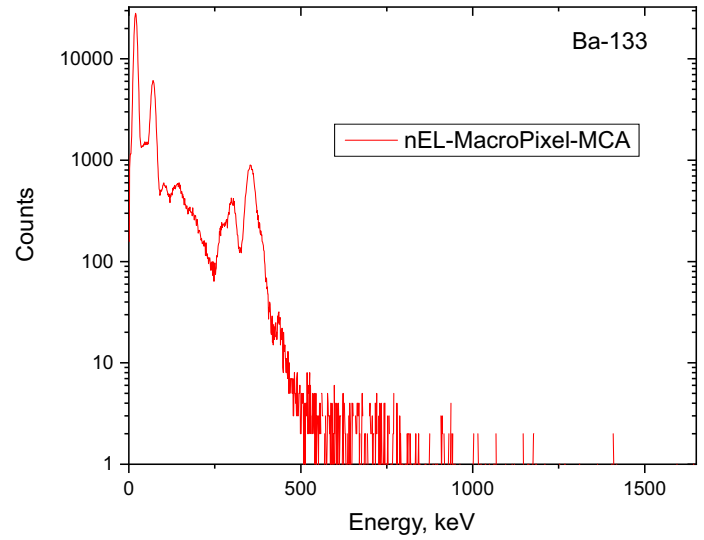
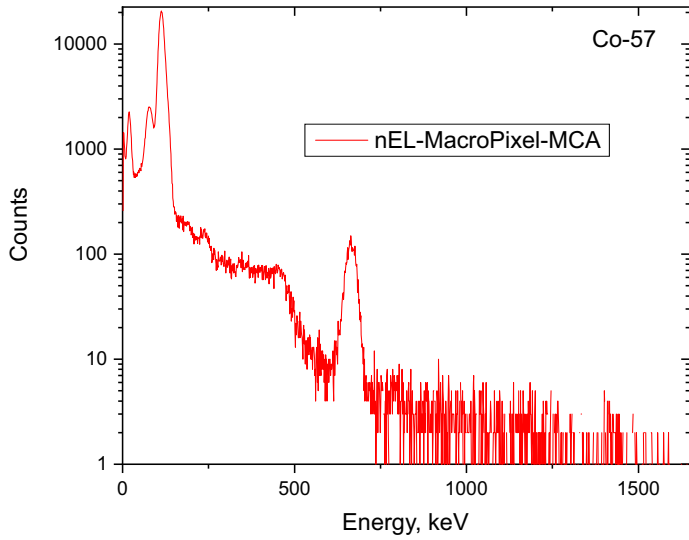

# Scintillation Probe nEL-MegaPixel-MCA



## 2D drawing

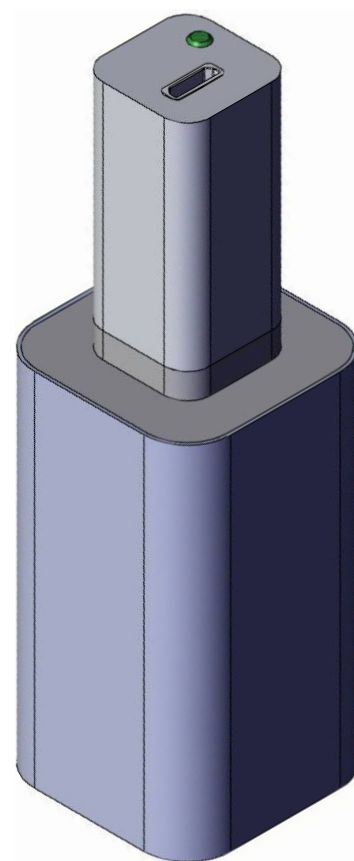
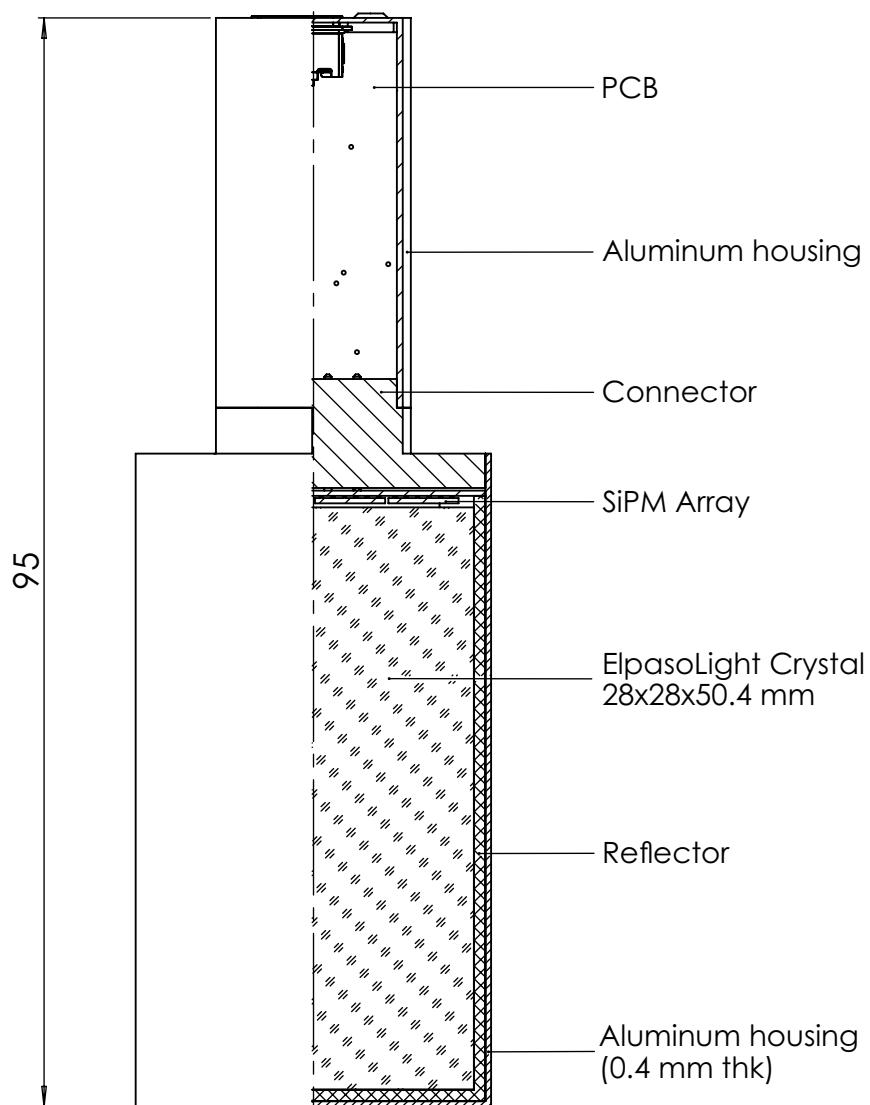
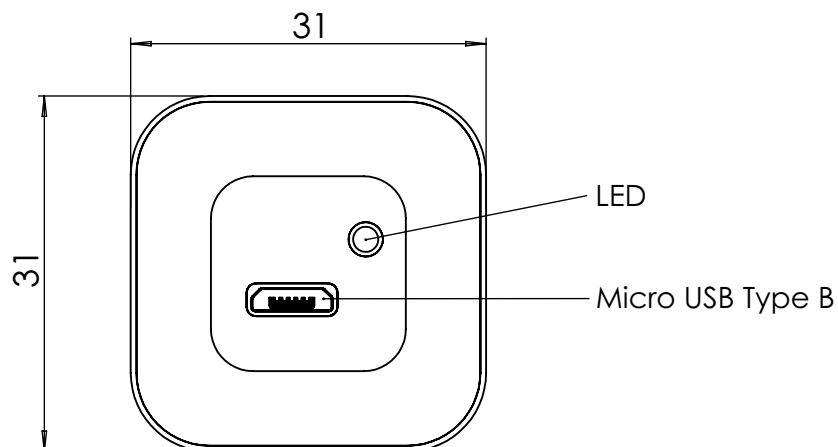

SCALE 1:1



### About CapeScint

CapeScint is a subsidiary of CapeSym, Inc. a multi-faceted company with 100+ years of combined experience in scintillators, semiconductors, and radiation detection instruments. CapeScint has its warehouse facilities and customer support staff located in Greater Boston Area, Massachusetts, USA.

Founded in 1992 as Cape Simulations, CapeSym, Inc. is now a multi-faceted company offering novel technical crystals and detectors for nuclear detection, including ScintiClear<sup>TM</sup> SrI<sub>2</sub>(Eu) and Elpasolight<sup>TM</sup> CLYC(Ce) scintillators. In addition, CapeSym offers radiation detection instruments and equipment through [www.zievert.com](http://www.zievert.com).



Our ongoing R&D leverages decades of experience in crystal growth, solid state physics, analytical chemistry, materials science, thermo-fluid transport, and engineering design. CapeScint as a subsidiary of CapeSym, Inc. has a long history working with the US Government as a contractor and as a supplier of essential goods and services. During the last 30 years CapeSym, Inc. and supported missions of multiple US Government agencies including NASA, MDA, USAF, DoE, DTRA, NIH, CWMD, and US Navy.



*Design and specifications are subject to change without notice*